

Mobile Home Tie-down Systems

Tie downs

- 100010 Cross Drive Anchor Only w/ 2-30" rods (8 per box)
- 100012 Cross Drive Anchor w/2-48" rods
- 100013 Cross drive Head Only
- 100011 STABIL X Cross Drive Anchor



- 100030 Concrete J-Hook (16 per bx)
- 100040 L.P. Tank Tie down kit (2-30" eye augers & 15' strap)

- 100050 Mollie-head & Bolt Anchors (50 per ctn.)
- 100051 Mollie-head only
- 100052 Mollie-bolt only
- 100072 36" Auger style (4 per pkg.)
- 100075 Auger Plate only
- 100076 48" Auger-style (4 per pkg.)
- 100077 36" STABIL X Auger style
- 100078 15" Eye Auger Anchor
- 100079 30" Eye Auger Anchor

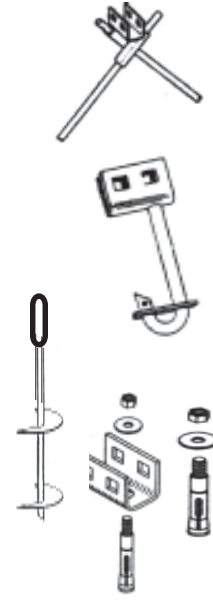

Straps

- 100058 7' Strap w/ 5/8" hole (8 per bdl.)
- 100059 7' Strap w/hook (8 per bdl.)
- 100060 7' Strap w/buckle (8 per bdl.)
- 100061 15' Strap w/hook (4 per bdle)
- 100062 Strap Coil (675' coil)
- 100063 Strap Crimps
- 100064 Buckle ends
- 100070 Split Bolts (8 per bag)

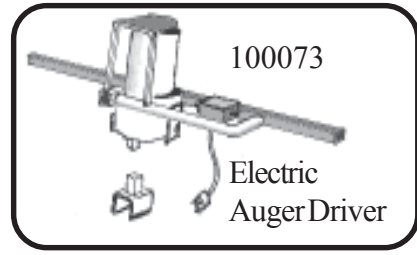

Blocks & Wedges

- 100534 2 x 12 x 24 Woods-P.T. (240 pallet)
- 200010 2 x 8 x 16 Woods (10 per pkg.)
- 200015 2 x 8 x 16 Woods-P.T. (10 per pkg.)
- 200019 4 x 4 x 24 Woods-ea (240 pallet)
- 200020 4 x 4 x 36 Woods
- 200025 4 x 6 x 36 Woods
- 200029 Wedges-16" (50 per bdl.-450 Per pallet)
- 200030 Wedges-12" (30 per bdl.)

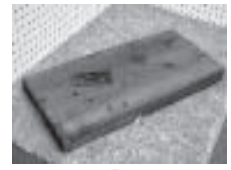

12 Ton Hydraulic Jacks

- 100550 Tall
- 100551 Short

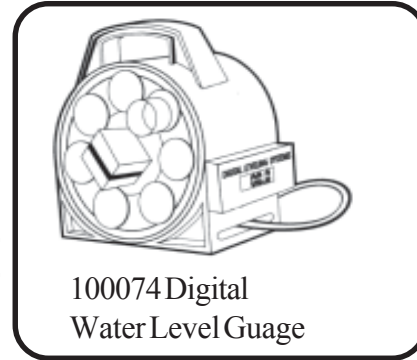

Set-Up Products

Code-certified Steel

Pier Stands

- 100525 8"
- 100526 10"
- 100508 12"
- 100509 14"
- 100510 16"
- 100511 18"
- 100512 20"
- 100513 22"
- 100514 24"
- 100515 26"
- 100516 28"
- 100517 30"
- 100518 32"
- 100523 34"
- 100524 36"
- 100530 Saddle top
- 100531 L-top
- 100532 Bolt-on for 5"- "Alaska" frame
- 100533 Flat Top
- 100536 Bolt-on for 4 3/4"
- 100537 10" L-top

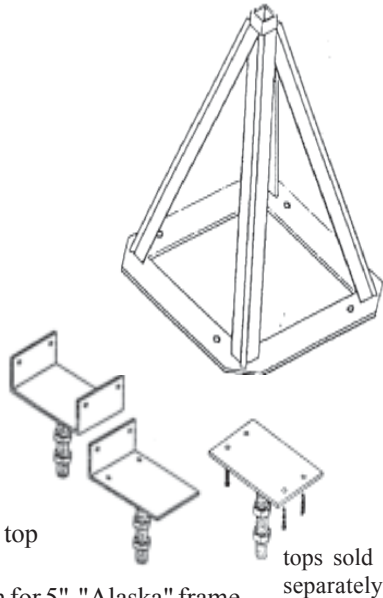

Magnum Foundation Systems

Earthquake Resistant Bracing

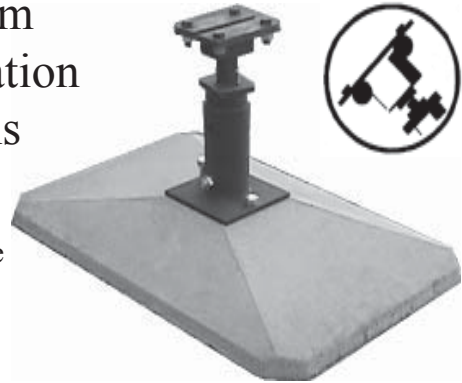

-conforms to FHA standards for permanent foundation status!

- 100501 size A 12" to 19"
- 100502 size B 16" to 23"
- 100503 size C 19 1/2" to 31"
- 100504 size D 24" to 38"
- 100505* size E 31" to 52"
- 100506* Cross-bracing for 100505

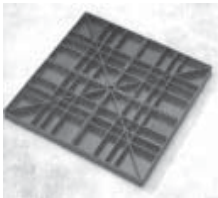

Pier Pads

- Code-approved
- Light weight
- affordable

100507-16" x 16"
A.B.S.Pier Pad

100535-20" x 20"
A.B.S.Pier Pad

Perimeter Jacks

- 100520 to 24"
- 100521 to 30"
- 100522 to 36"



200040
Temporary Wooden Steps

3/8" x 5" Lag Bolts & Washers

- 100193 Lag bolts-(qty-300)
- 100194 Lag Bolts -each
- 100195 Washers-(qty.-50)
- 100196 Washrs-each



Hex Head Screws

Zinc plated

- 100179 #8 x 1/2-50ct.
- 100178 #8 x 3/4-100ct.
- 100184 #8 x 3/4-500ct
- 100185 #8 x 3/4-1000ct.

- 100182 #8 x 1 1/4-50ct.
- 100183 #8 x 1 1/4-100ct.
- 100189 #8 x 1 1/4-500ct..

White Headed

- 100190 #8 x 3/4-50ct.
- 100186 #8 x 1 1/4-50ct.
- 100187 #8 x 1 1/4-100ct.
- 100188 #8 x 1 1/4-500ct.

Self-Tapping Screws

- 110102-W #8 x 1/2 White-25ct.
- 110102-B #8 x 1/2 Brown-25ct.
- 110102-WL #6 x 3/4 White-25ct.
- 110102-BL #6 x 3/4 Brown-25ct.

Siding Nails

- 150301 2 1/4" Galv. Nails-(50lb. box)

